

1QR406

DESCRIZIONE Vasca Quadra R"12" 316 incasso bordo piatto, filo e sottotop 40x40 cm
DESCRIPTION 40x40 cm 316 built-in flat edge, flush and undermounted Square Bowl with radius "12"

PESO LORDO 6,5 kg
GROSS WEIGHT

DIMENSIONI IMBALLO 495x495x270
PACKAGING DIMENSIONS

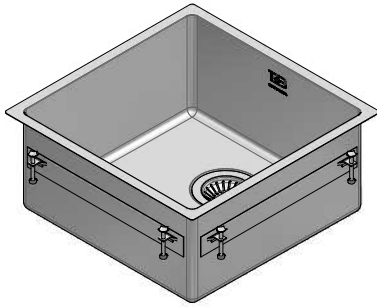

- Acciaio Inox AISI 316 di spessore elevato (AISI 316 extra thick stainless steel)
 - Vasca Quadra raggio "12" (Square Bowl with radius "12")
 - Dimensione Vasca: 40x40x20 h (40x40x20 h bowl dimension)
 - Dotazioni: (A) pilettona 3"1/2, troppo pieno B (Equipment: 3"1/2 basket strainer waste, overflow B)
 - Base inserimento vasca: incasso e filo 50cm, sottotop 60cm (Base unit for bowl: built-in 50cm, undermount 60cm)
 - Incasso: 42x42 cm (Built-in: 42x42 cm)*
 - Filotop: 44,3x44,3 cm (Flush: 44,3x44,3 cm)*
 - Sottotop: 39,6x39,6 cm (Undermount: 39,6x39,6 cm)
- * + Intaglio per troppopieno (+ cut-out for overflow)

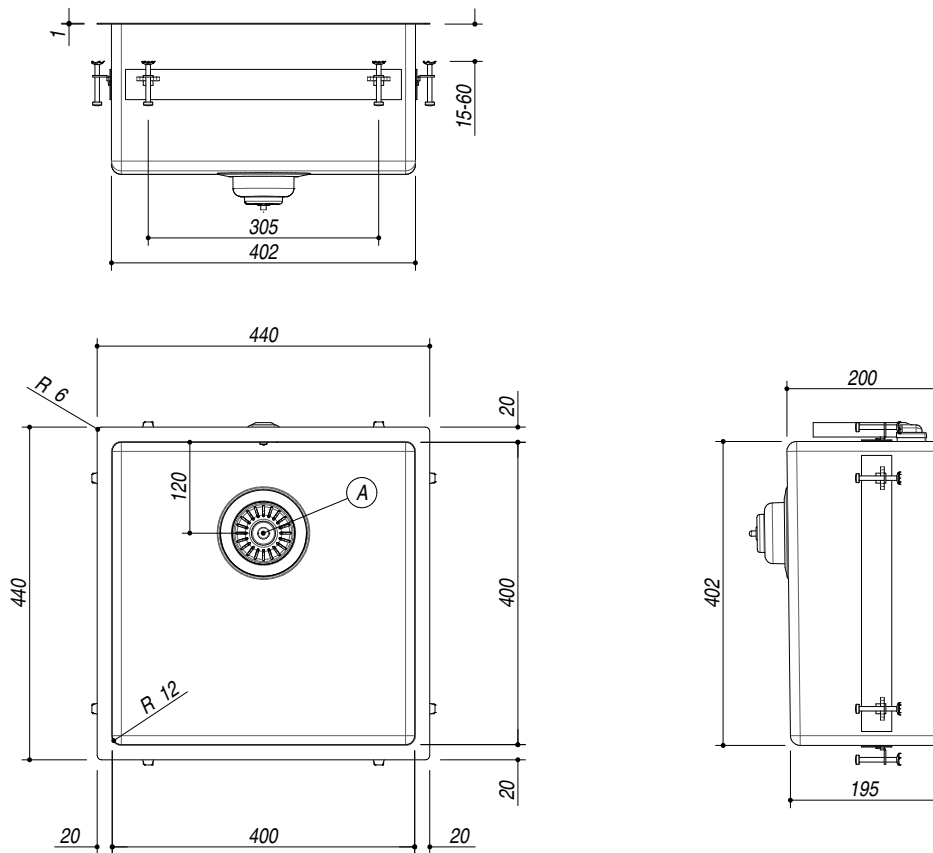

SCALA DISEGNO 1:10
DRAWING SCALE

TUTTE LE MISURE IN mm
ALL MEASURES IN mm

TOLLERANZA LINEARE: ± 0.5 mm
LINEAR TOLERANCE

TOLLERANZA ANGOLARE: ± 0.2 °
ANGULAR TOLERANCE

FORATURA PER INSTALLAZIONE AD INCASSO
BUILT-IN CUTOUT FOR TOP

FORATURA PER INSTALLAZIONE A FILO
FLUSH CUTOUT FOR TOP

FORATURA PER INSTALLAZIONE SOTTOTOP
UNDERMOUNT CUTOUT FOR TOP

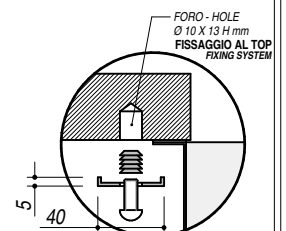
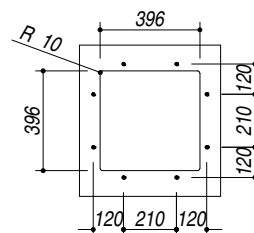
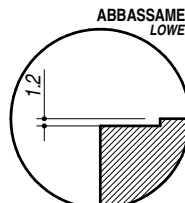
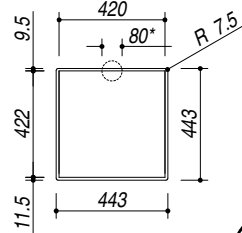
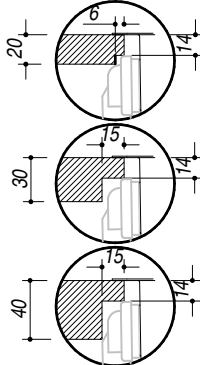
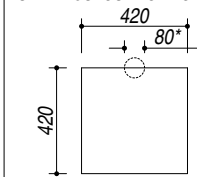

1:30

1:30